

Applications / Markets



Yacht Controls



Security Devices



Industrial Controls

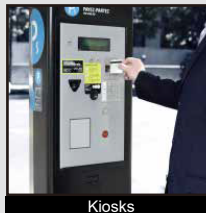

Kiosks



Car Controls



Medical Equipment



RoHS

Specifications

Electrical Rating: 21A, 24VDC
Mechanical Life: 1,000,000 Cycles
Electrical Life: 50,000 Cycles
Contact Resistance: 50m Ω Max.
Insulation Resistance: 1000 M Ω Min.
Dielectric Strength: 2,000VAC
Operating/Storage Temperature: -20°C to 55°C
Travel: 1.50mm
Moisture Protection: IP67
Actuation Force: 4N
Panel Thickness: 1-11mm
Mounting Nut Torque: 5-14Nm

Features & Benefits

- 19mm diameter panel cutout
- Variety LED option
- Dot, ring or power symbol illumination available
- Multiple actuator options
- Pilot indicator option
- IP65 rated,
- Momentary Off-(On), Latching Off-On
- Output type: NPN

PART NUMBER CONFIGURATOR

Series	Actuator Options	Terminal Options	Function Options	Rating Options	Material Options	Illumination Style Options	LED-Color Options	Illumination Voltage Options	Graphic (Optional)
L19Y	<input type="checkbox"/> F - Flat <input type="checkbox"/> H - High	<input type="checkbox"/> C - Cable*	<input type="checkbox"/> M - Momentary Off-(On) <input type="checkbox"/> Z - Latching Off - On	<input type="checkbox"/> NONE - Max. 21A24V DC	<input type="checkbox"/> S - Stainless Steel <input type="checkbox"/> A - Black Anodized	<input type="checkbox"/> NONE - Non-Illuminated <input type="checkbox"/> D - Dot Illumination <input type="checkbox"/> R - Ring Illumination	<input type="checkbox"/> NONE - Non-Illuminated <input type="checkbox"/> W - White <input type="checkbox"/> R - Red <input type="checkbox"/> O - Orange <input type="checkbox"/> G - Green <input type="checkbox"/> B - Blue <input type="checkbox"/> Y - Yellow <input type="checkbox"/> RG - Red/Green <input type="checkbox"/> RB - Red/Blue	<input type="checkbox"/> NONE - Non-Illuminated <input type="checkbox"/> 1 - Base Voltage**	<input type="checkbox"/> M01 - Power symbol laser etched

NOTES:
 () denotes function is momentary
 * Cable length 1200mm
 ** The base voltage for rating

Specifications subject to change without notice

Big current anti vandal switch Φ 19mm

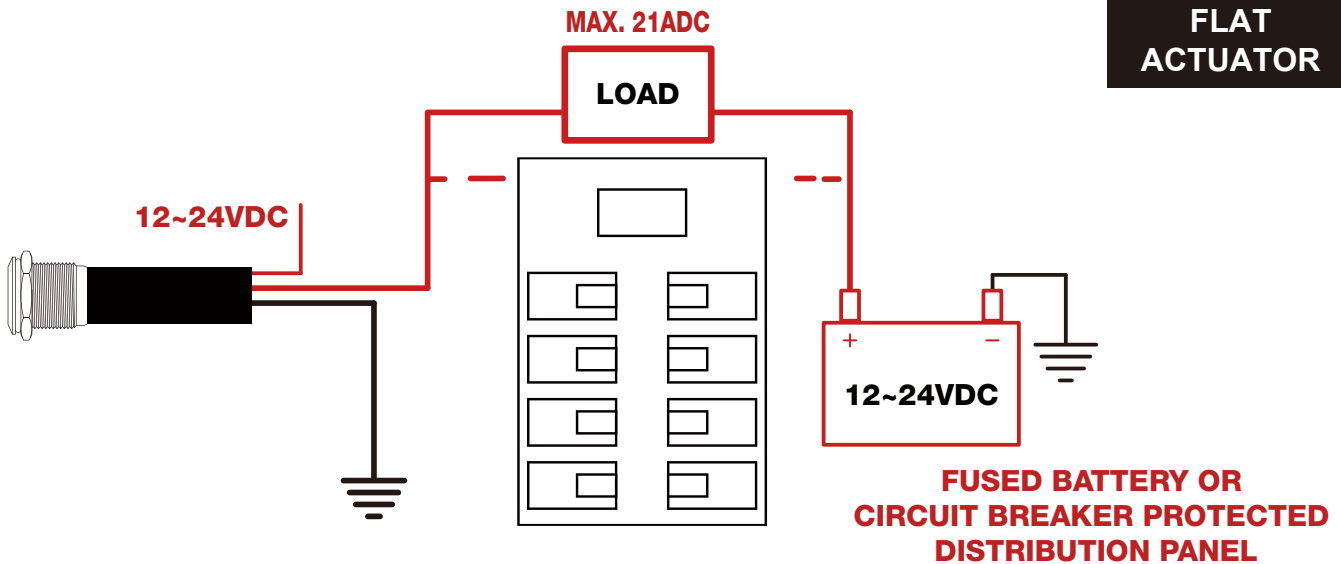
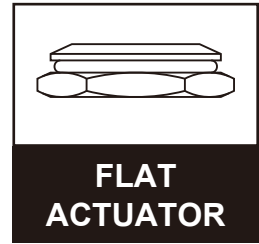
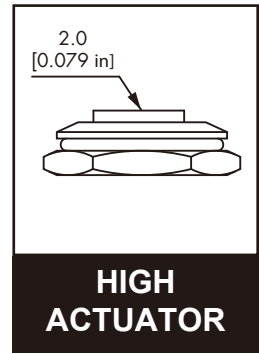
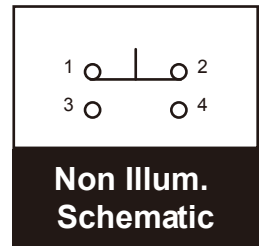
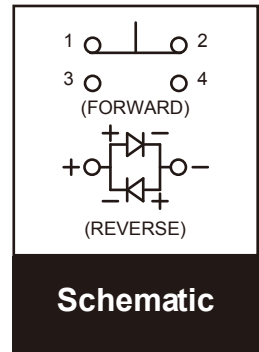
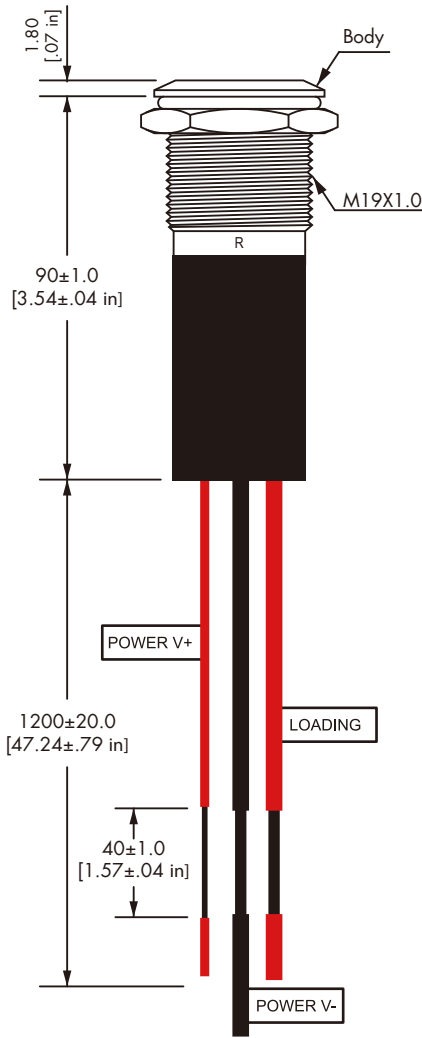
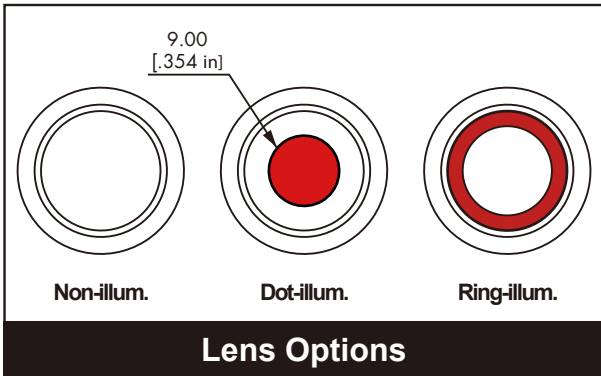
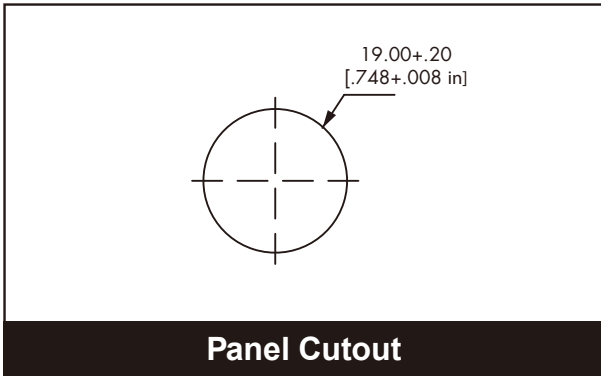
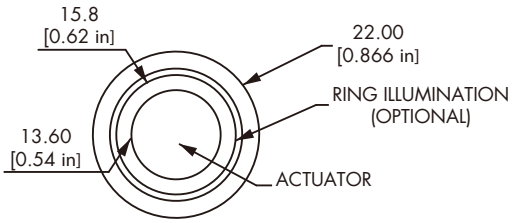

! Important: Proper wiring must be followed!
Improper wiring may cause damage to switch